

Not indicated size- and shape tolerances: EN

Not indicated wall thickness:

Design Date: 7-2-2023

Printed on: 4-9-2023

EUROPEAN PROJECTION

Designed by:

sheet: 1 of 6

unit of measure: mm

finish:

lx=

ly=

scale
1:1

Surface area: -

Coating surface:

STATUS
WIP

PLAN-NUMBER

D23-00018 - #_00

Material:

S.G.: g/cm³

Volume: -

Weight: -

ARTICLE-NUMBER

PROPERTY OF
HAROL®

Industriepark 3 - 3290 DIEST
TEL. 013/38 01 11 - Fax. 013/31 48 03

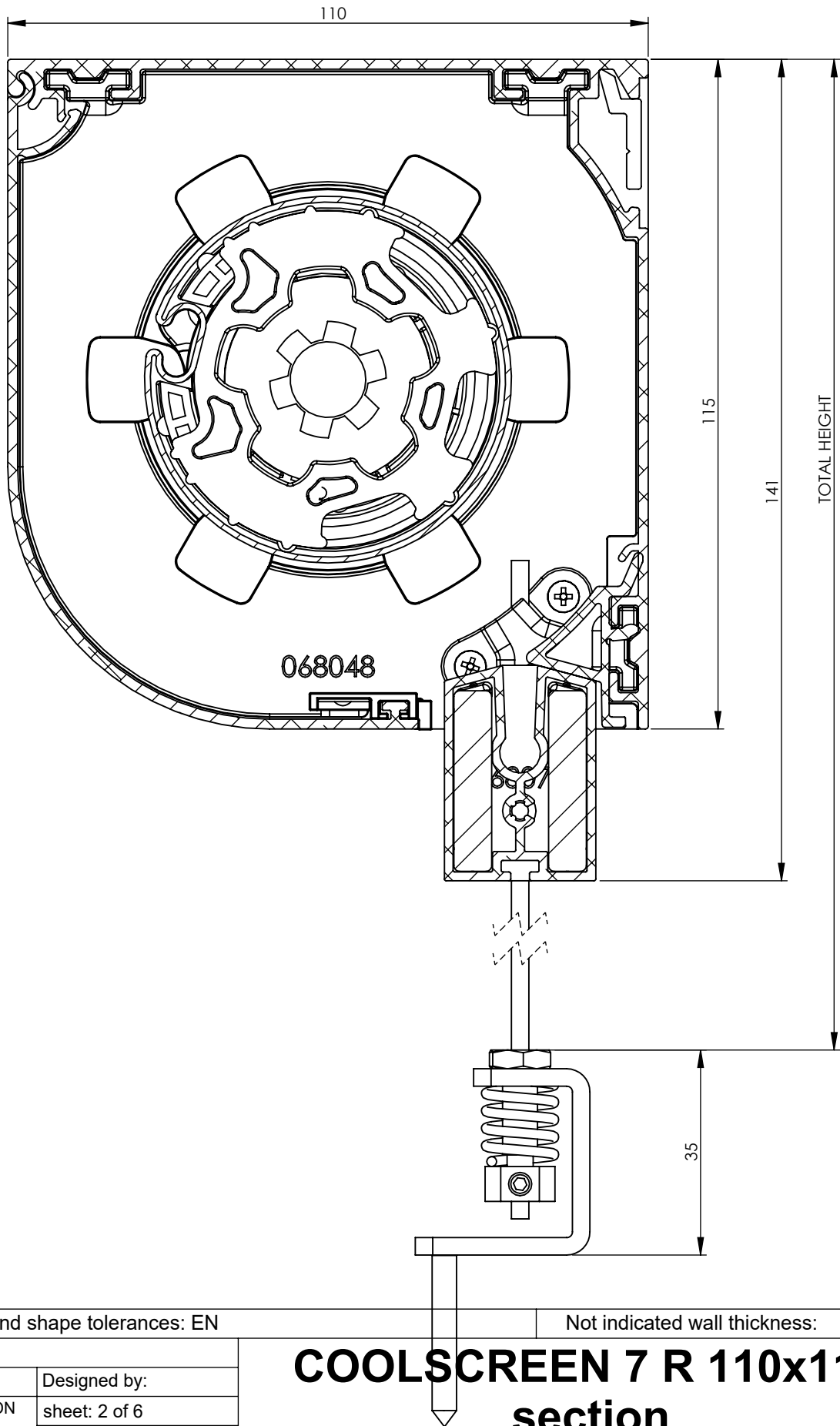

Not indicated size- and shape tolerances: EN

Not indicated wall thickness:

Design Date: 7-2-2023

Printed on: 4-9-2023

EUROPEAN PROJECTION

Designed by:

sheet: 2 of 6

unit of measure: mm

finish:

Surface area: -

Material:

Volume: -

lx=

Coating surface:

S.G.: g/cm³

Weight: -

ly=

STATUS

PLAN-NUMBER

ARTICLE-NUMBER

PROPERTY OF
HAROL[®]

Industriepark 3 - 3290 DIEST
TEL. 013/38 01 11 - Fax. 013/31 48 03

scale
1:1

WIP

D23-00018 - #_00

COOLSCREEN 7 R 110x115 section

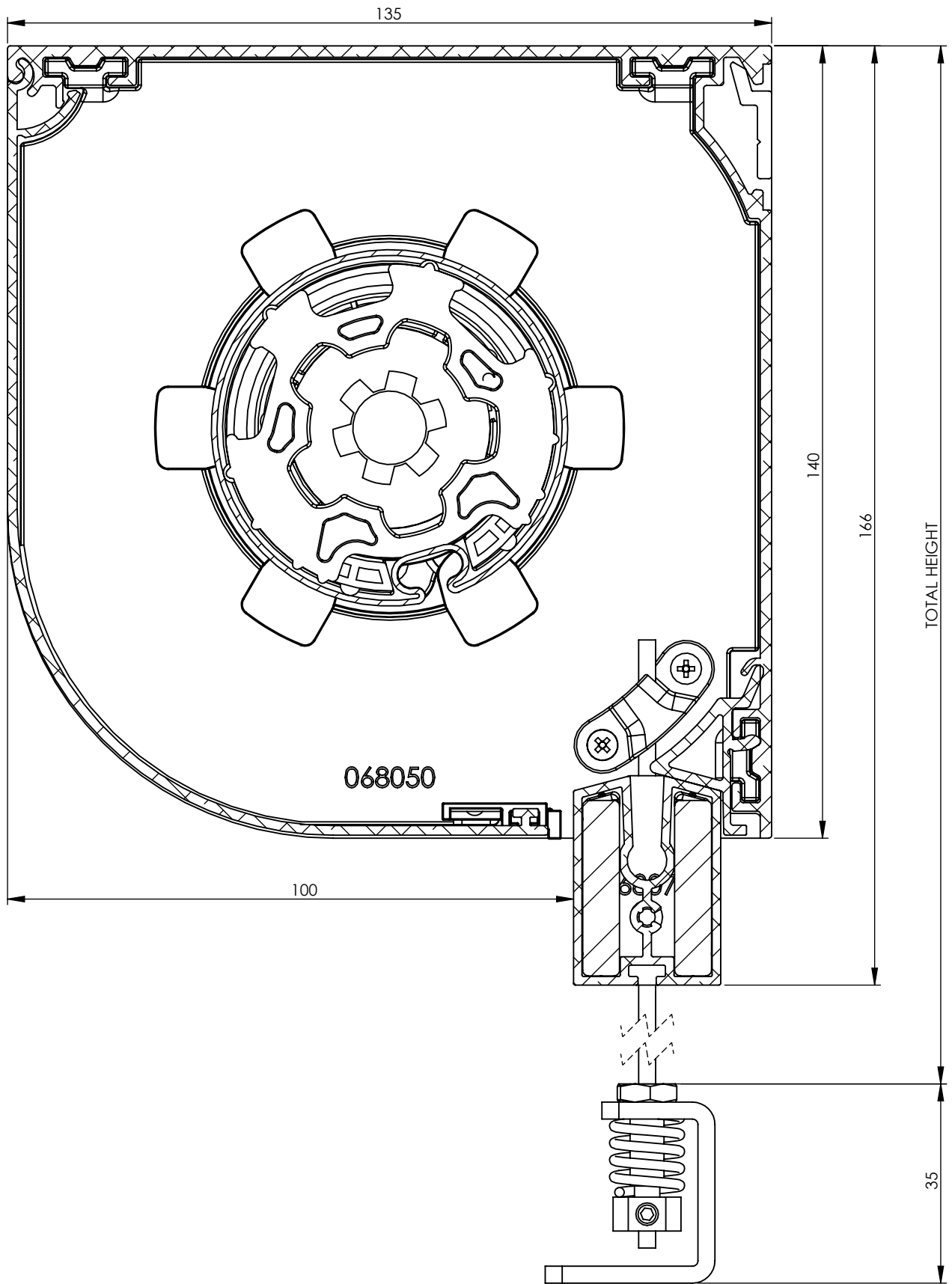

Not indicated size- and shape tolerances: EN

Not indicated wall thickness:

Design Date: 7-2-2023

Printed on: 4-9-2023

EUROPEAN PROJECTION

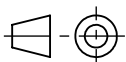

Designed by:

sheet: 3 of 6

unit of measure: mm

finish:

lx=

ly=

scale
1:1

COOLSCREEN 7 R 135x140 section

Surface area: -

Coating surface:

Material:

S.G.: g/cm³

Volume: -

Weight: -

PROPERTY OF

HAROL[®]

Industriepark 3 - 3290 DIEST
TEL. 013/38 01 11 - Fax. 013/31 48 03

STATUS

WIP

PLAN-NUMBER

D23-00018 - #_00

ARTICLE-NUMBER

SIDE VIEW section

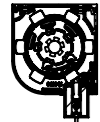

SIDE VIEW right

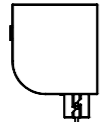

FRONT VIEW

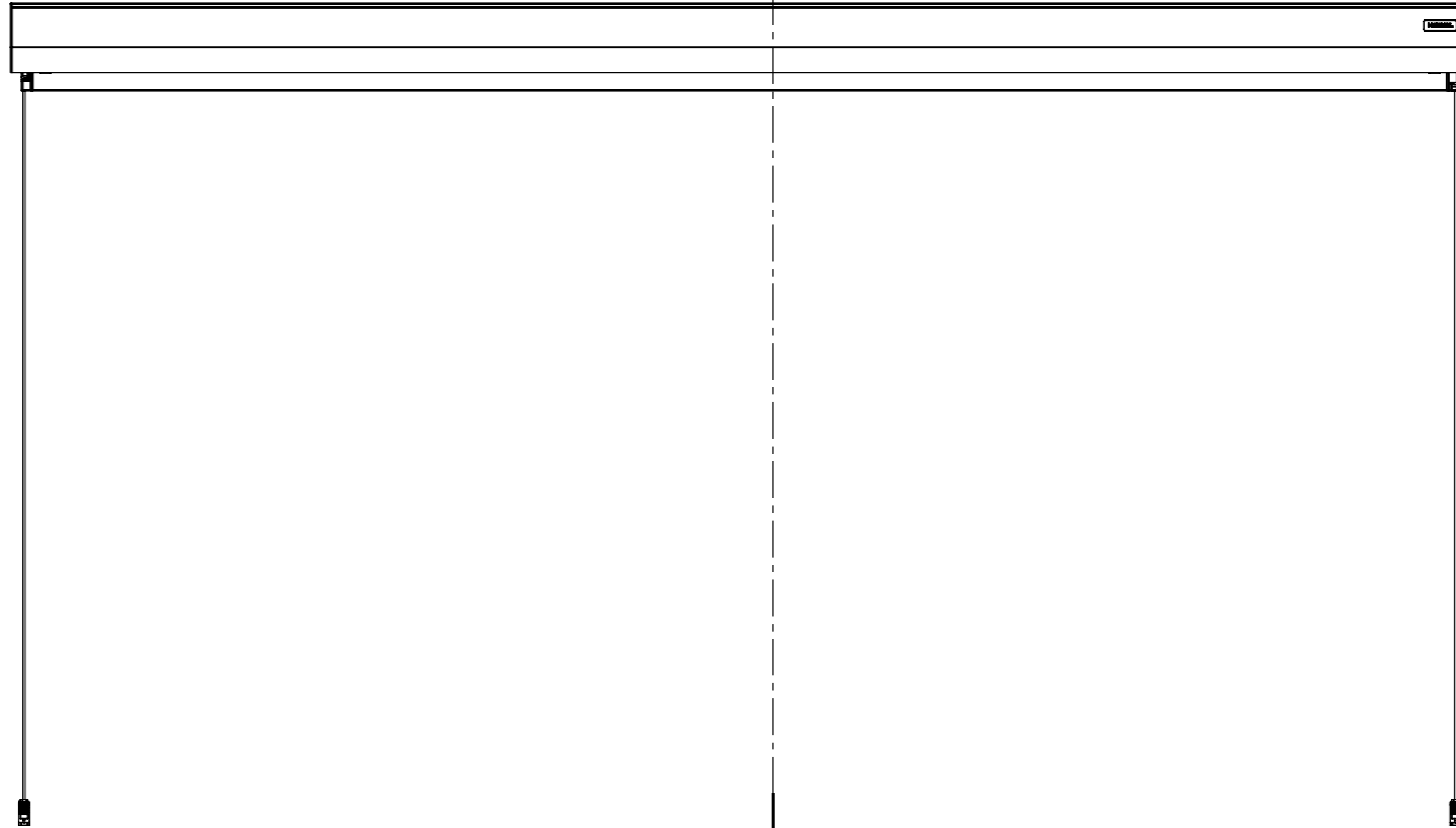

SIDE VIEW right

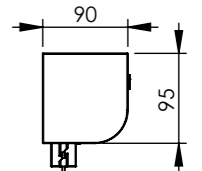

P-P

TOP VIEW

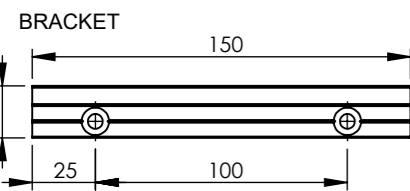

(1:3)

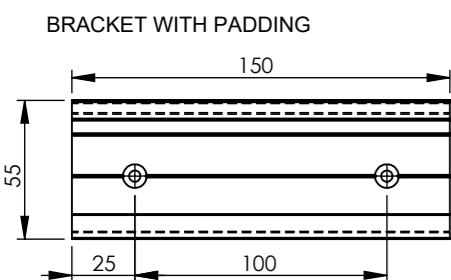

(1:3)

Not indicated size- and shape tolerances: EN		Not indicated wall thickness:			
Design date: 7-2-2023		Coolscreen 7 R 90 x 95			
Printed on: 4-9-2023	Designed by: Harol				
EUROPEAN PROJECTION	Sheet: 4 of 6 Unit of measure: mm				
	Finish: BRUT	Surface area: -	Material: ALU	Volume: -	
	PROPERTY OF HAROL [®] Industriepark 3 - 3290 DIEST TEL. 013/38 01 11 - Fax. 013/31 48 03	lx= ly=	Coating surface:	S.G.:	Weight: -
SCALE 1:8		STATUS WIP	PLAN-NUMBER D23-00018 - #_00	ARTICLE-NUMBER	

SIDE VIEW section

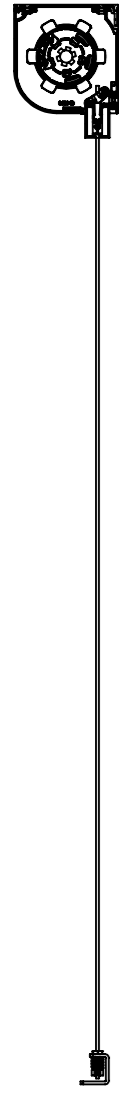

Q-Q

SIDE VIEW right

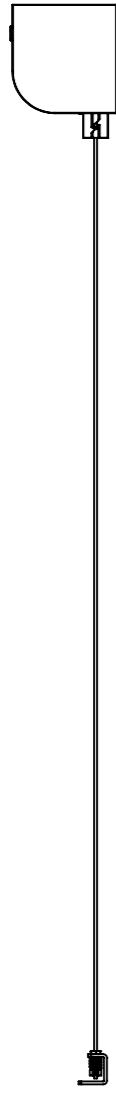

FRONT VIEW



SIDE VIEW left

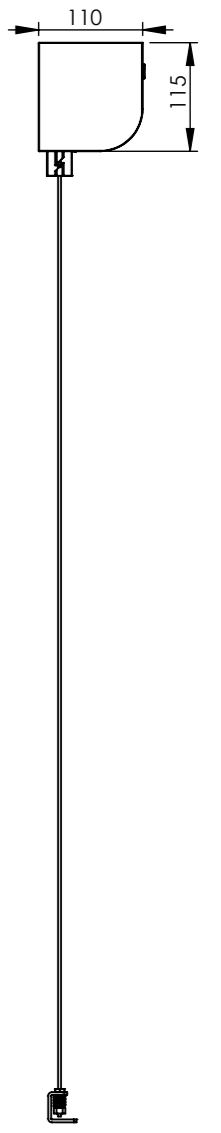

BRACKET

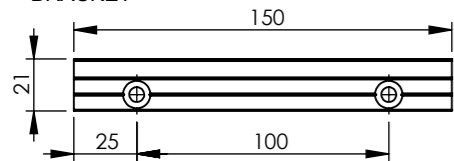

(1:3)

BRACKET WITH PADDING

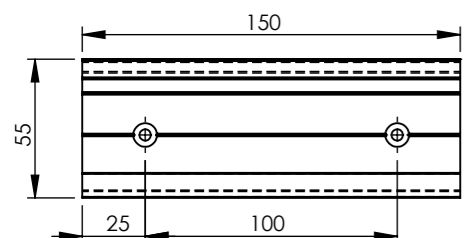

(1:3)

TOP VIEW

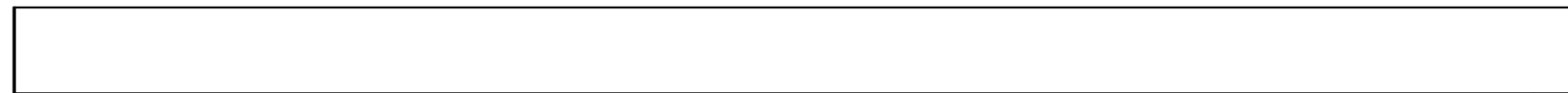

Not indicated size- and shape tolerances: EN

Not indicated wall thickness:

Design date: 7-2-2023

Printed on: 4-9-2023

EUROPEAN PROJECTION

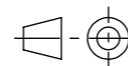

PROPERTY OF
HAROL[®]
Industriepark 3 - 3290 DIEST
TEL. 013/38 01 11 - Fax. 013/31 48 03

Designed by: Harol

Sheet: 5 of 6

Unit of measure: mm

Finish: BRUT

lx=

ly=

SCALE
1:8

Coolscreen 7 R 110 x 115

Surface area: -

Coating surface: --- mm²/m

Material: ALU

S.G.: 0.002.76 g/cm³

Volume: -

Weight: -

STATUS

WIP

PLAN-NUMBER

D23-00018 - #_00

ARTICLE-NUMBER

SIDE VIEW section

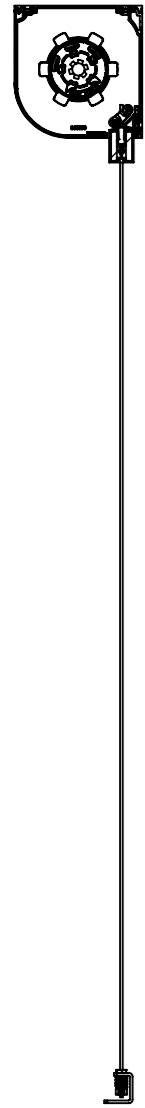

SIDE VIEW right

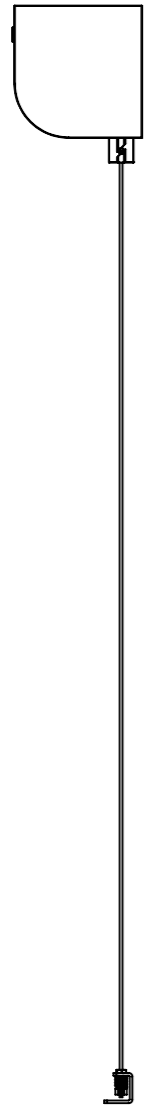

FRONT VIEW



SIDE VIEW left

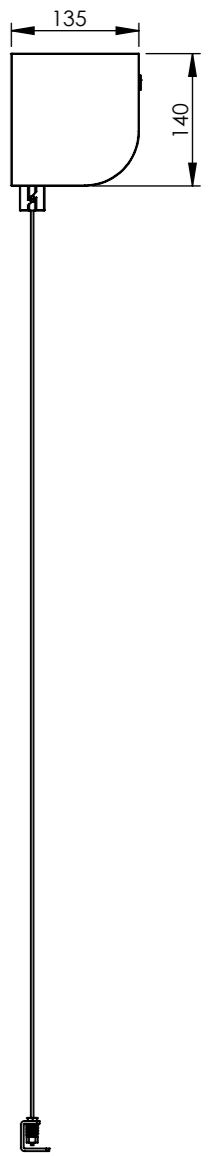

R-R

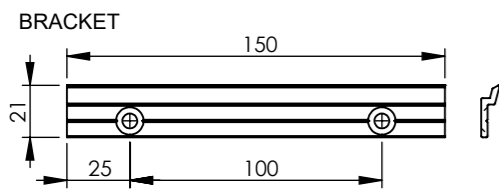

(1:3)

BRACKET WITH PADDING

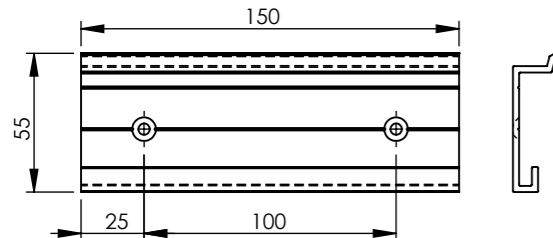

(1:3)

TOP VIEW



Not indicated size- and shape tolerances: EN

Not indicated wall thickness:

Design date: 7-2-2023

Printed on: 4-9-2023

EUROPEAN PROJECTION

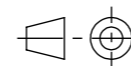

PROPERTY OF

HAROL[®]

Industriepark 3 - 3290 DIEST
TEL. 013/38 01 11 - Fax. 013/31 48 03

Designed by: Harol

Sheet: 6 of 6

Unit of measure: mm

Finish: BRUT

lx=

ly=

SCALE
1:8

Coolscreen 7 R

135 x 140

Surface area: -

Coating surface:

Material: ALU

S.G.:

Volume: -

Weight: -

STATUS

WIP

PLAN-NUMBER

D23-00018 - #_00

ARTICLE-NUMBER