

Not indicated size- and shape tolerances: EN

Not indicated wall thickness:

Design Date: 7-2-2023

Printed on: 29-8-2023

EUROPEAN PROJECTION

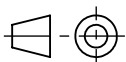

Designed by:

sheet: 1 of 7

unit of measure: mm

finish: BRUT

lx=

ly=

scale
1:2

COOLSCREEN LED 90x123 section

Surface area: -

Coating surface:

Material:

S.G.: g/cm³

Volume: -

Weight: -

PROPERTY OF

HAROL[®]

Industriepark 3 - 3290 DIEST
TEL. 013/38 01 11 - Fax. 013/31 48 03

STATUS

WIP

PLAN-NUMBER

D23-00003 - #_00

ARTICLE-NUMBER

XXxxX

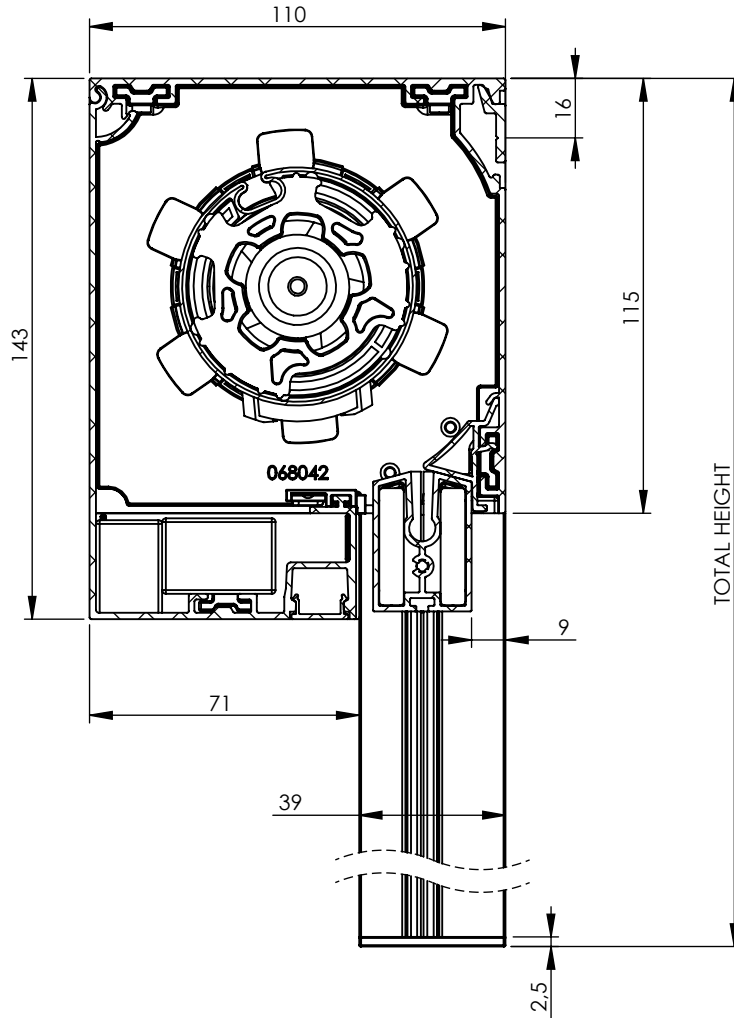

Not indicated size- and shape tolerances: EN

Not indicated wall thickness:

Design Date: 7-2-2023

Printed on: 29-8-2023

EUROPEAN PROJECTION

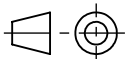

Designed by:

sheet: 2 of 7

unit of measure: mm

finish: BRUT

lx=

ly=

scale
1:2

COOLSCREEN LED 110x143 section

Surface area: -

Coating surface:

Material:

S.G.: g/cm³

Volume: -

Weight: -

STATUS

WIP

PLAN-NUMBER

D23-00003 - #_00

ARTICLE-NUMBER

XXxxX

PROPERTY OF
HAROL®

Industriepark 3 - 3290 DIEST
TEL. 013/38 01 11 - Fax. 013/31 48 03

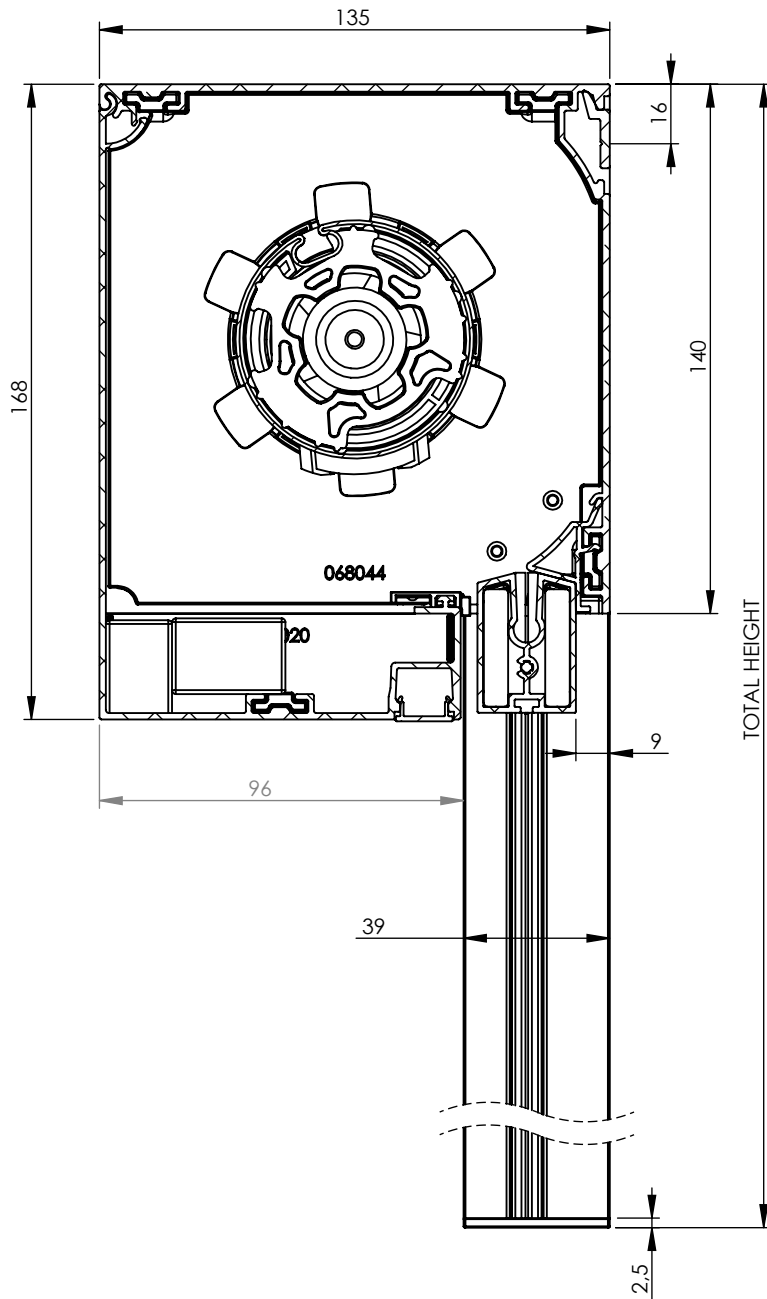

Not indicated size- and shape tolerances: EN

Not indicated wall thickness:

Design Date: 7-2-2023

Printed on: 29-8-2023

EUROPEAN PROJECTION

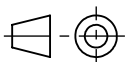

Designed by:

sheet: 3 of 7

unit of measure: mm

finish: BRUT

lx=

ly=

scale
1:2

COOLSCREEN LED 135x168 section

Surface area: -

Coating surface:

Material:

S.G.: g/cm³

Volume: -

Weight: -

PROPERTY OF

HAROL®

Industriepark 3 - 3290 DIEST
TEL. 013/38 01 11 - Fax. 013/31 48 03

STATUS

WIP

PLAN-NUMBER

D23-00003 - #_00

ARTICLE-NUMBER

XXxxX

SIDE VIEW section



I-I

SIDE VIEW Right



FRONT VIEW

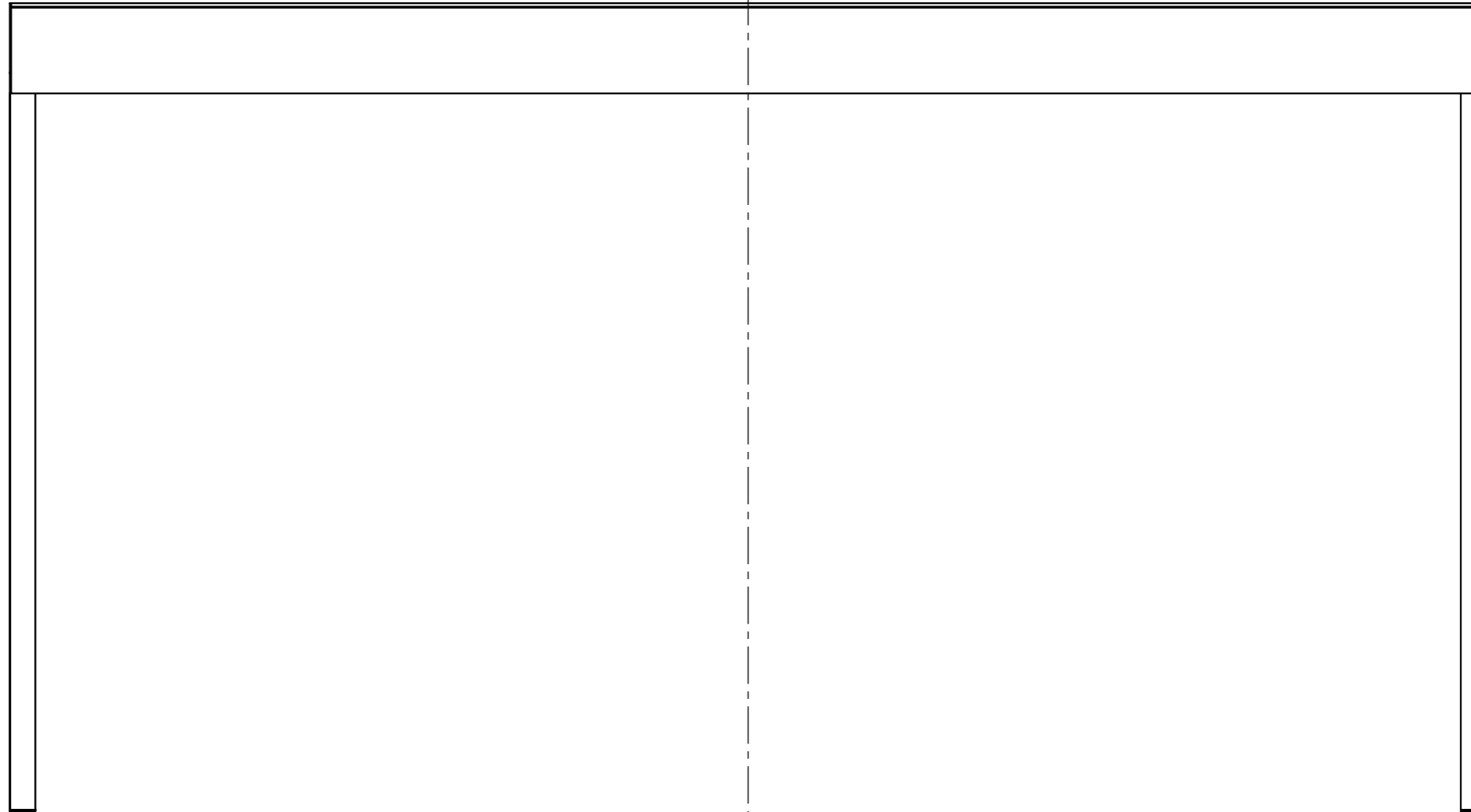

SIDE VIEW Left

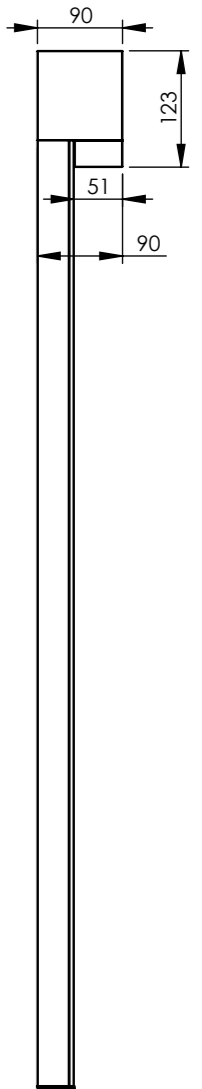

TOP VIEW

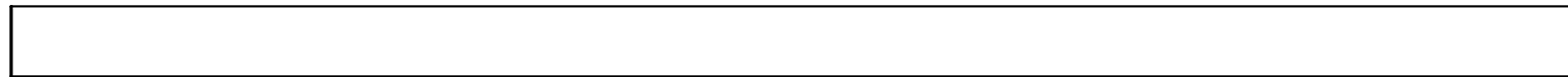

BRACKET

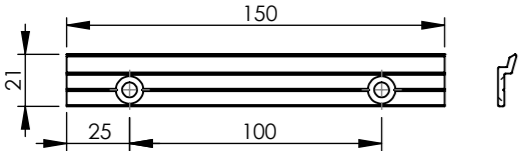

(1:3)

BRACKET WITH PADDING

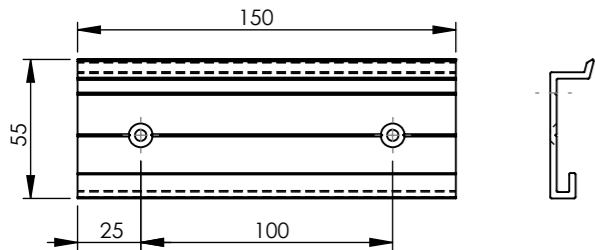

(1:3)

GUIDE

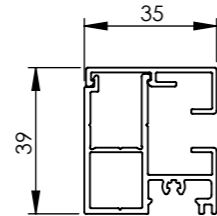

(1:2)

GUIDE WITH FILLING

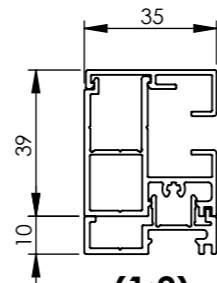

(1:2)

Not indicated size- and shape tolerances: EN

Not indicated wall thickness:

Design date: 7-2-2023

Printed on: 29-8-2023

EUROPEAN PROJECTION

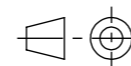

PROPERTY OF

HAROL[®]

Industriepark 3 - 3290 DIEST
TEL. 013/38 01 11 - Fax. 013/31 48 03

Designed by: Harol

Sheet: 4 of 7

Unit of measure: mm

Finish: BRUT

Ix=

Iy=

SCALE
1:8

Coolscreen 8 LED

90 x 143

Surface area:

Coating surface:

Material:

S.G.:

Volume:

Weight:

STATUS

WIP

PLAN-NUMBER

D23-00003 - #_00

ARTICLE-NUMBER

SIDE VIEW section

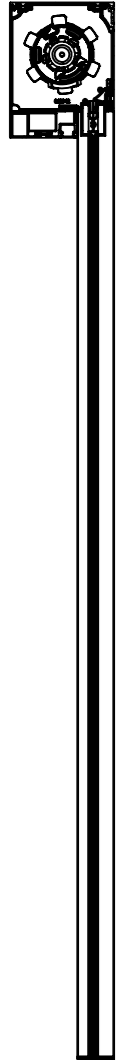

SIDE VIEW right

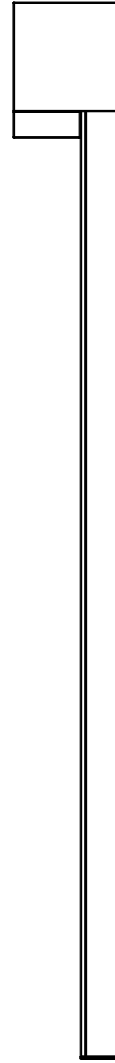

FRONT VIEW

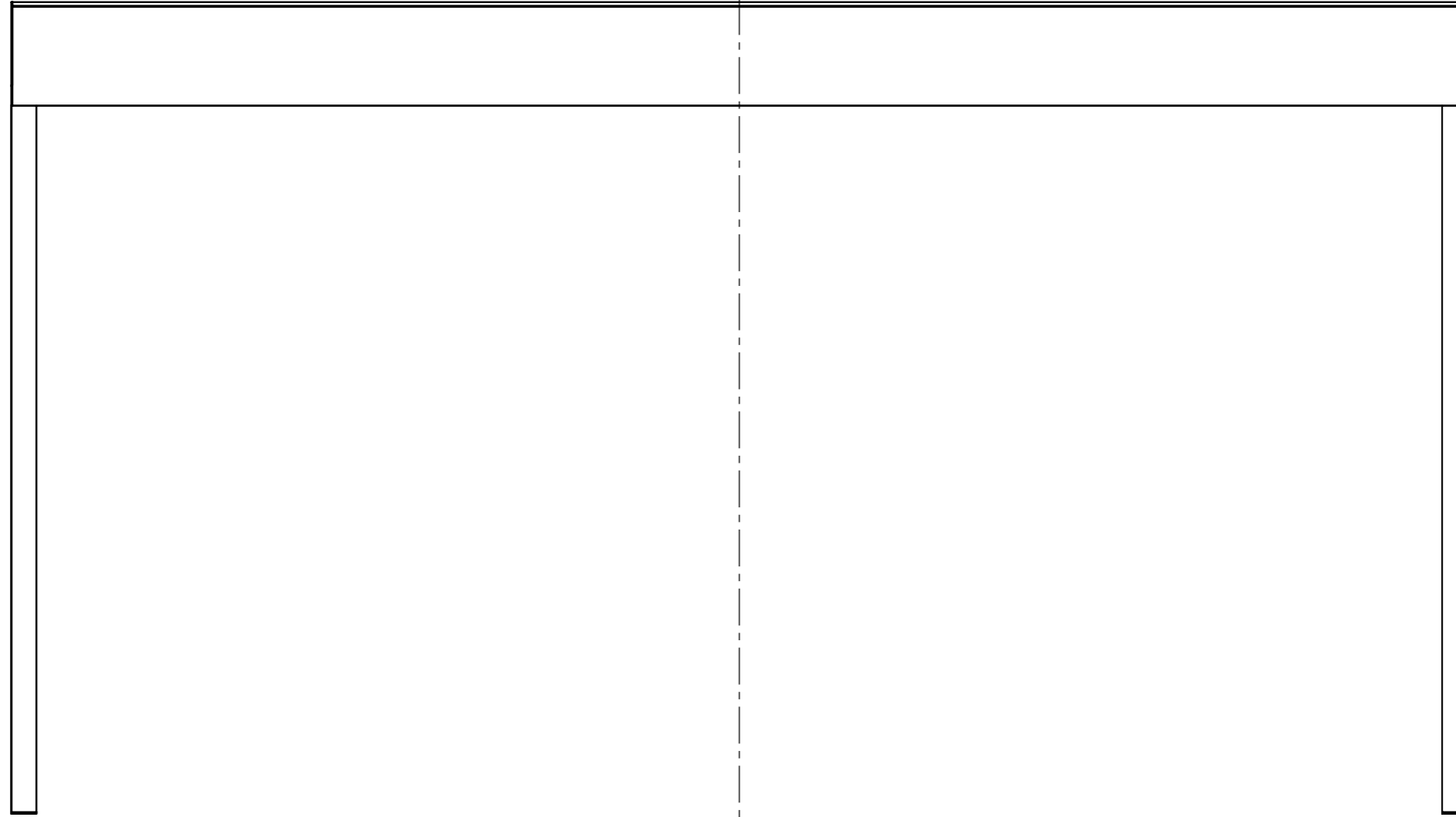

SIDE VIEW left

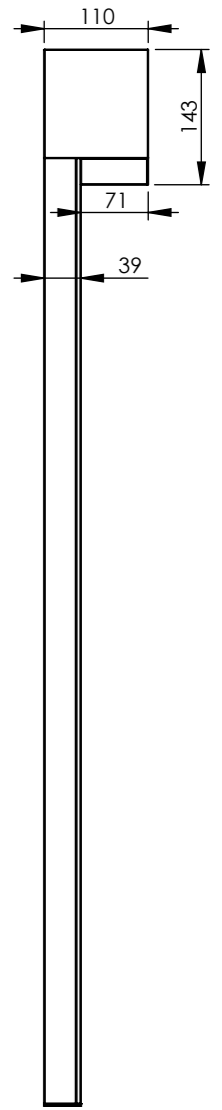

A-A (1 : 8)

TOP VIEW



BRACKET

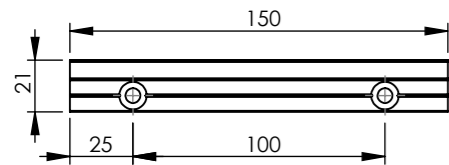

(1:3)

BRACKET WITH PADDING

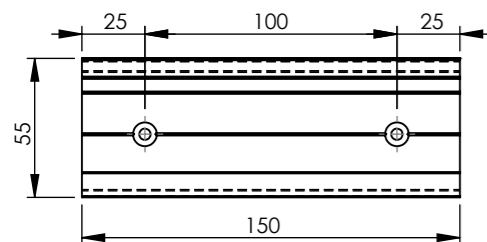

(1:3)

GUIDE

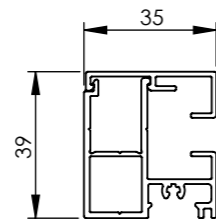

(1:2)

GUIDE WITH FILLING

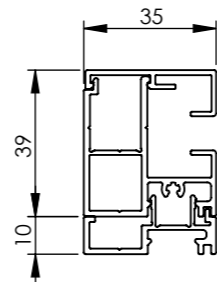

(1:2)

Not indicated size- and shape tolerances: EN

Not indicated wall thickness:

Design date: 7-2-2023

Printed on: 29-8-2023

EUROPEAN PROJECTION

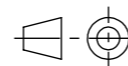

PROPERTY OF
HAROL[®]
Industriepark 3 - 3290 DIEST
TEL. 013/38 01 11 - Fax. 013/31 48 03

Designed by:

Sheet: 5 of 7

Unit of measure: mm

Finish: BRUT

lx=

ly=

SCALE
1:8

Coolscreen 8 LED 110 x 143

Surface area: -

Coating surface:

Material:

S.G.: g/cm³

Volume: -

Weight: -

STATUS

WIP

PLAN-NUMBER

D23-00003 - #_00

ARTICLE-NUMBER

XXxxX

SIDE VIEW section

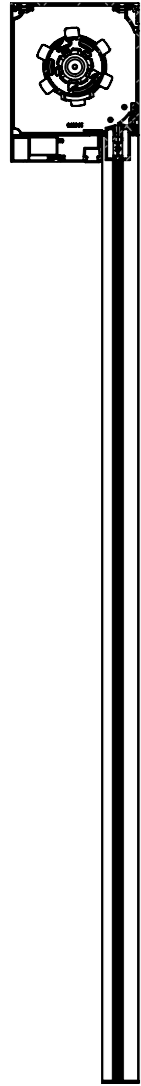

SIDE VIEW right

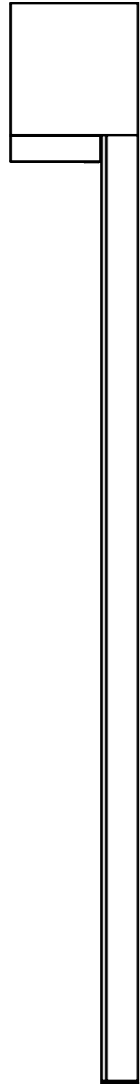

FRONT VIEW

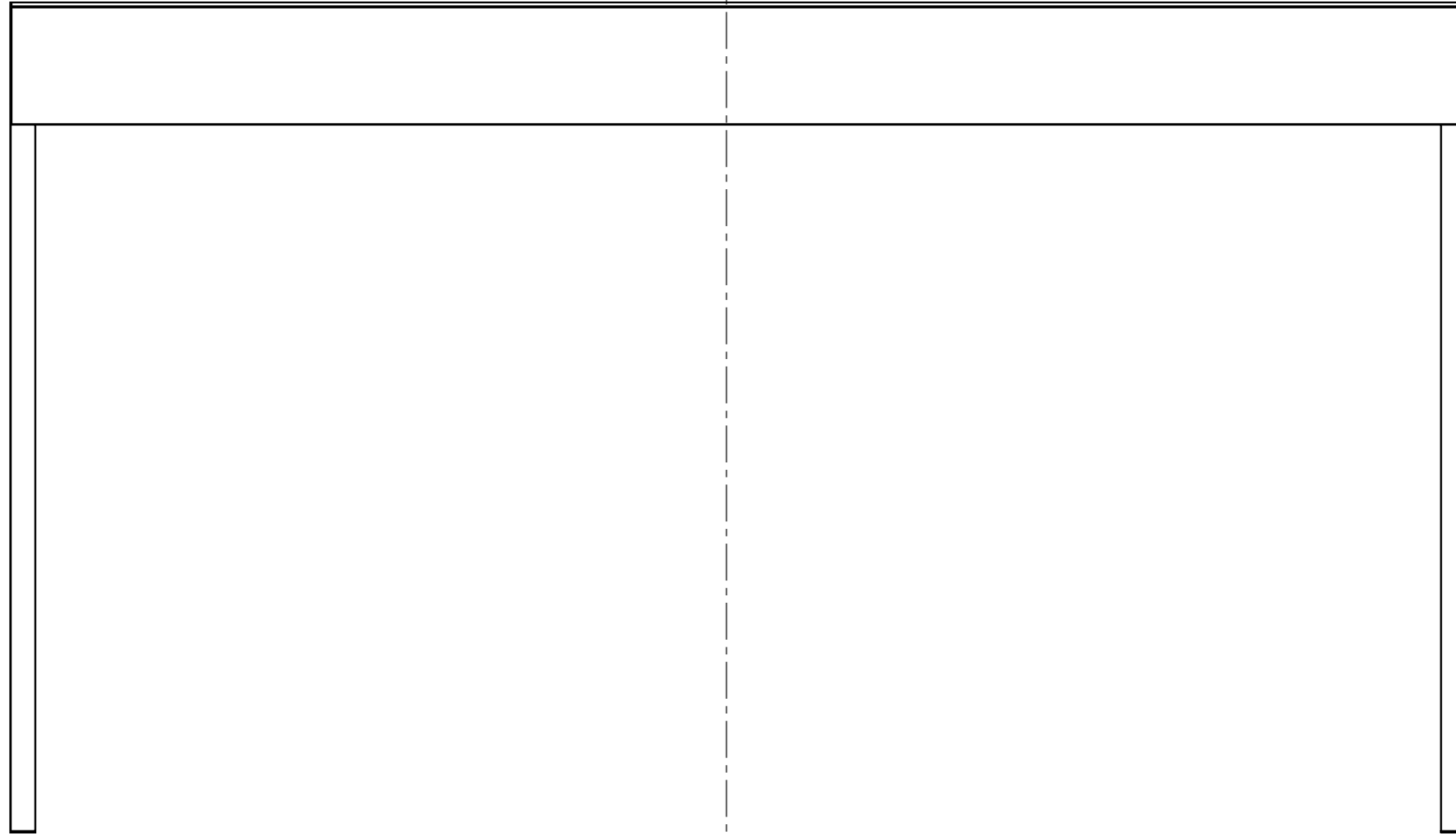

SIDE VIEW left

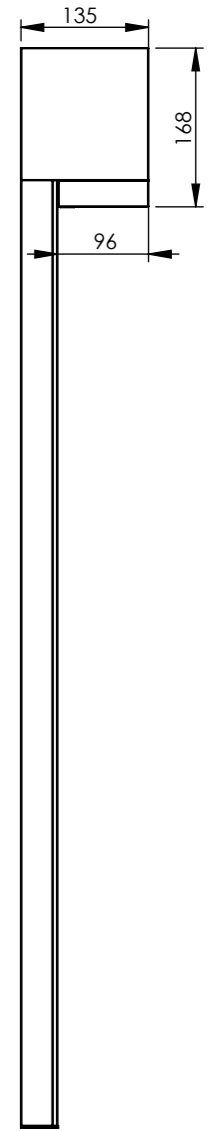

K-K (1 : 8)



TOP VIEW



BRACKET

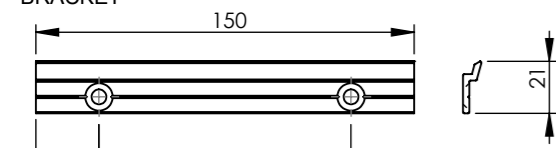

(1:3)

BRACKET WITH PADDING

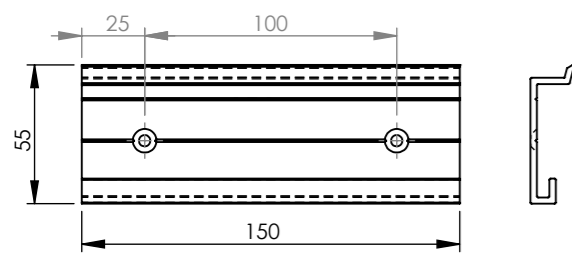

(1:3)

GUIDE

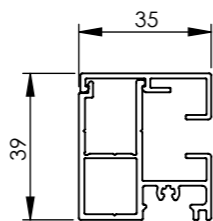

(1:2)

GUIDE WITH FILLING

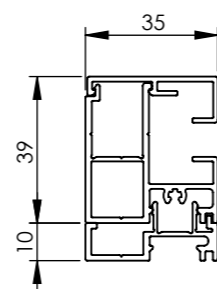

(1:2)

Not indicated size- and shape tolerances: EN

Not indicated wall thickness:

Design date: 7-2-2023

Printed on: 29-8-2023

EUROPEAN PROJECTION

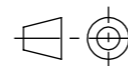

PROPERTY OF

HAROL

Industriepark 3 - 3290 DIEST
TEL. 013/38 01 11 - Fax. 013/31 48 03

Designed by:

Sheet: 6 of 7

Unit of measure: mm

Finish: BRUT

lx=

ly=

SCALE
1:8

Coolscreen 8 LED 135 x 168

Surface area: 6671216.40

Material:

Volume: 6695946.98

Coating surface:

S.G.: g/cm³

Weight: 3284622107.57

STATUS

PLAN-NUMBER

ARTICLE-NUMBER

WIP

D23-00003 - #_00

XXxxX

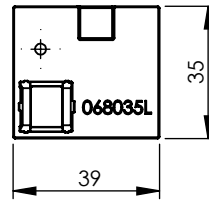
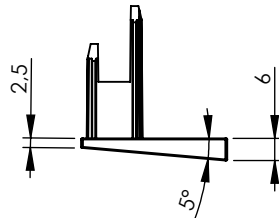
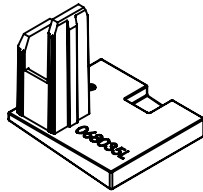
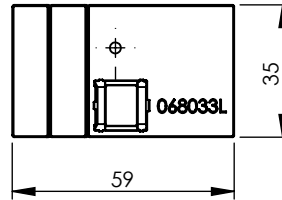
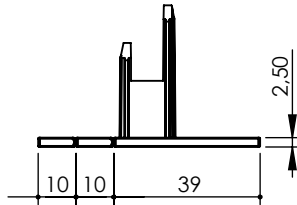
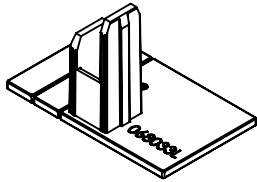
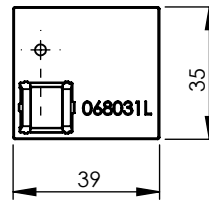
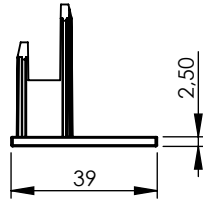
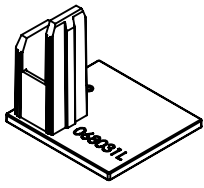

Not indicated size- and shape tolerances: EN

Not indicated wall thickness:

Design Date: 7-2-2023

Printed on: 29-8-2023

EUROPEAN PROJECTION

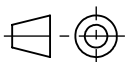

Designed by: mm

sheet: 7 of 7

unit of measure: mm

finish: NEUTRAAL

lx=

ly=

scale
1:1

Surface area:

Coating surface:

STATUS

WIP

PLAN-NUMBER

D23-00003 - #_00

Material:

S.G.:

Volume:

Weight:

ARTICLE-NUMBER

068031

PROPERTY OF
HAROL®

Industriepark 3 - 3290 DIEST
TEL. 013/38 01 11 - Fax. 013/31 48 03

HAROL Coolscreen Eindstoppen