

Not indicated size- and shape tolerances: EN

Not indicated wall thickness:

Design Date: 7-2-2023

Printed on: 22-8-2023

EUROPEAN PROJECTION

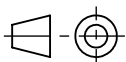

Designed by:

sheet: 1 of 7

unit of measure: mm

finish: BRUT

lx=

ly=

scale
1:1

COOLSCREEN 8 R 90x95 section

Surface area: -

Coating surface:

Material:

S.G.: g/cm³

Volume: -

Weight: -

PROPERTY OF

HAROL[®]

Industriepark 3 - 3290 DIEST
TEL. 013/38 01 11 - Fax. 013/31 48 03

STATUS

WIP

PLAN-NUMBER

D23-00002 - #_00

ARTICLE-NUMBER

XXxxX

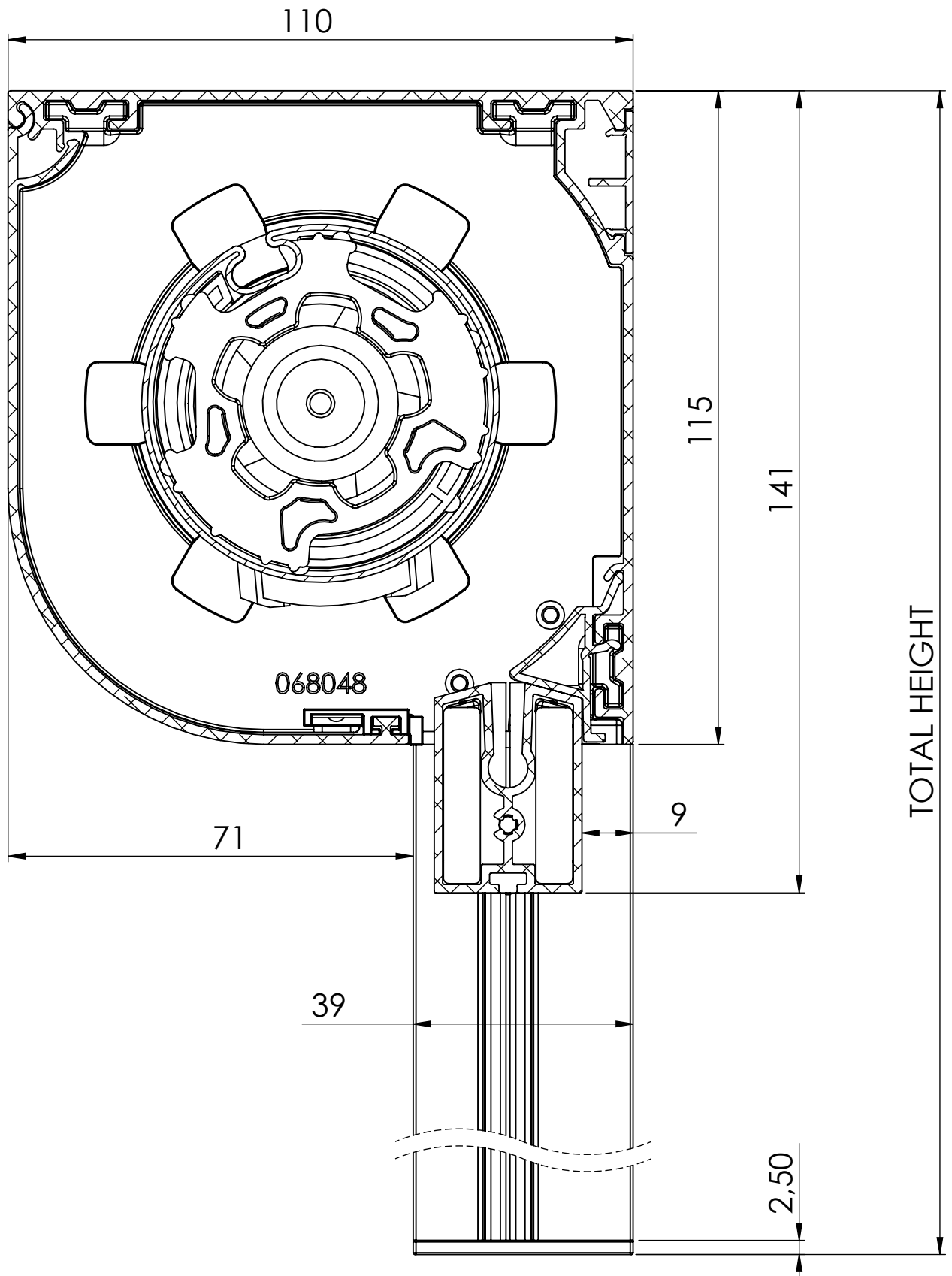

Not indicated size- and shape tolerances: EN

Not indicated wall thickness:

Design Date: 7-2-2023

Printed on: 22-8-2023

EUROPEAN PROJECTION

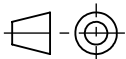

Designed by:

sheet: 2 of 7

unit of measure: mm

finish: BRUT

lx=

ly=

scale
1:1

COOLSCREEN 8 R 110x115 section

Surface area: -

Coating surface:

Material:

S.G.: g/cm³

Volume: -

Weight: -

PROPERTY OF

HAROL[®]

Industriepark 3 - 3290 DIEST
TEL. 013/38 01 11 - Fax. 013/31 48 03

STATUS

WIP

PLAN-NUMBER

D23-00002 - #_00

ARTICLE-NUMBER

XXxxX

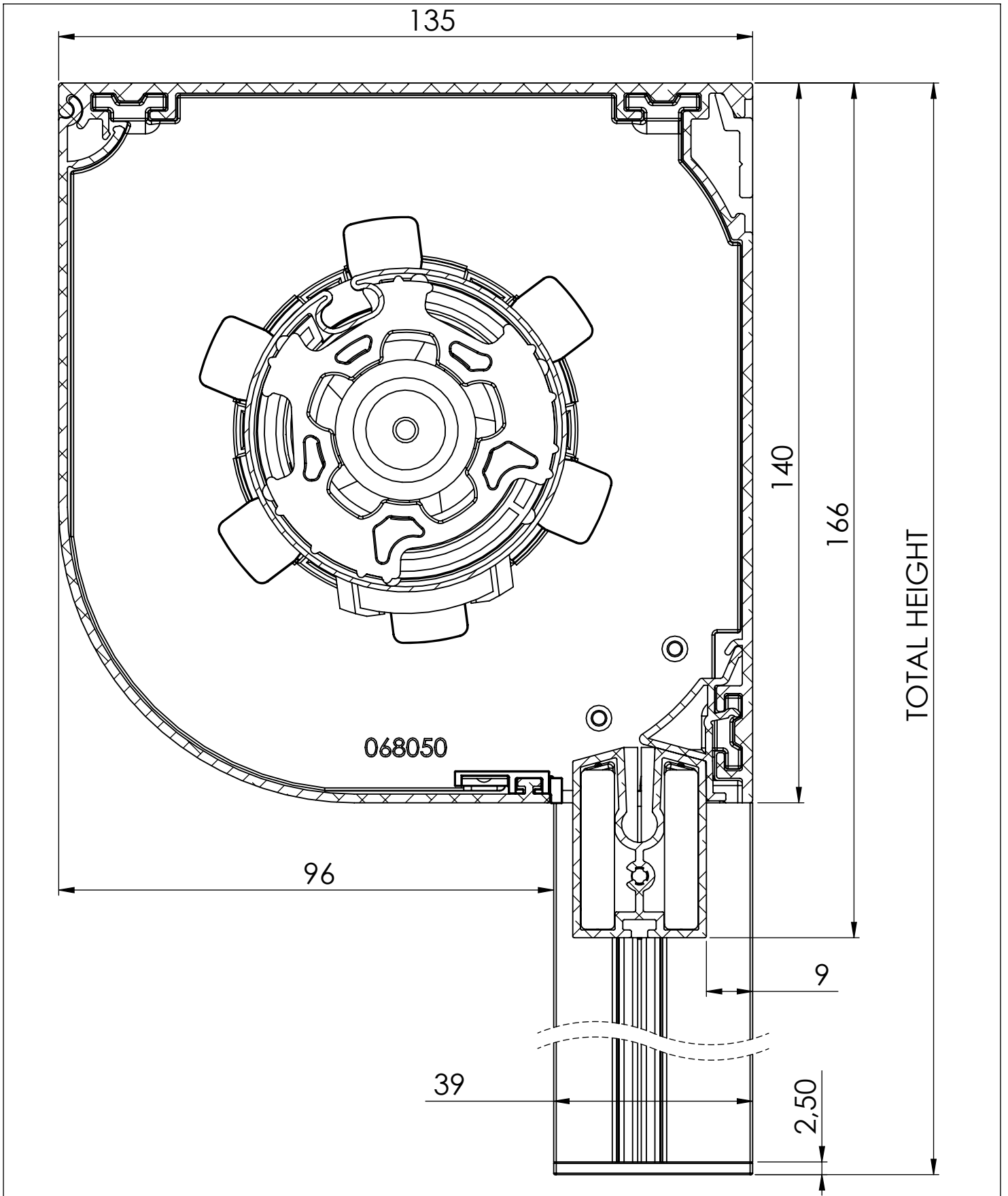

Not indicated size- and shape tolerances: EN

Not indicated wall thickness:

Design Date: 7-2-2023

Printed on: 22-8-2023

EUROPEAN PROJECTION

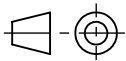

Designed by:

sheet: 3 of 7

unit of measure: mm

finish: BRUT

lx=

ly=

scale
1:1

COOLSCREEN 8 R 135x140 section

Surface area: -

Coating surface:

Material:

S.G.: g/cm³

Volume: -

Weight: -

PROPERTY OF

HAROL[®]

Industriepark 3 - 3290 DIEST
TEL. 013/38 01 11 - Fax. 013/31 48 03

STATUS

WIP

PLAN-NUMBER

D23-00002 - #_00

ARTICLE-NUMBER

XXxxX

SIDE VIEW section



I-I

SIDE VIEW right



FRONT VIEW

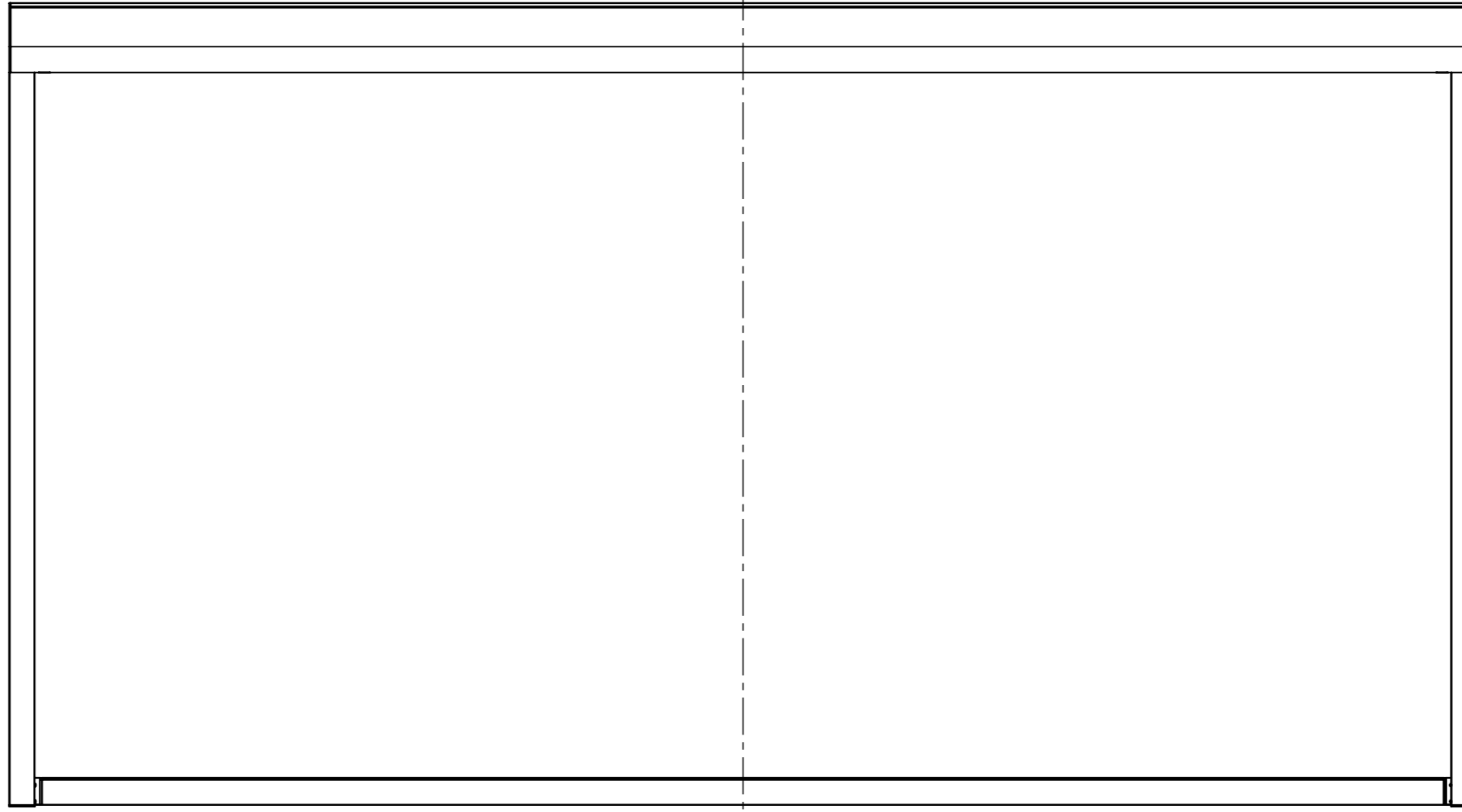

SIDE VIEW right

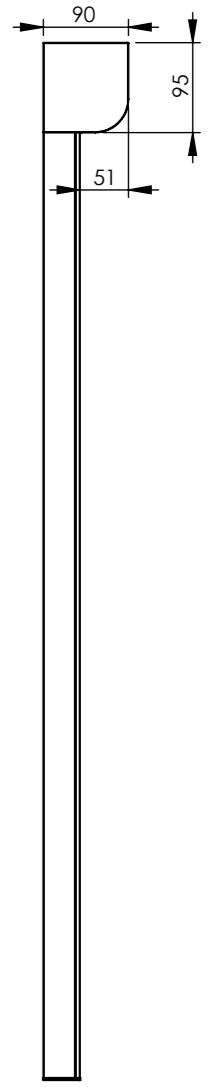

TOP VIEW

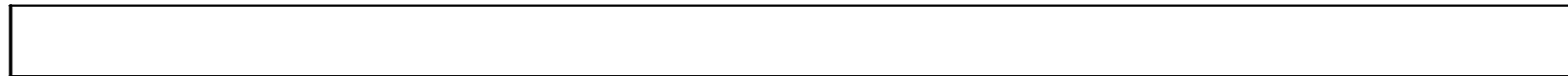

BRACKET

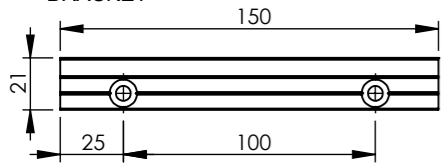

(1:3)

BRACKET WITH PADDING

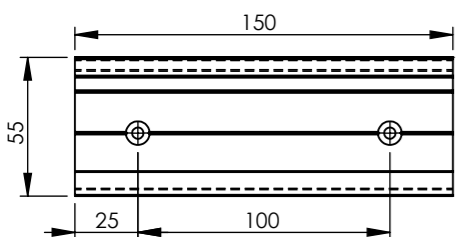

(1:3)

GUIDE

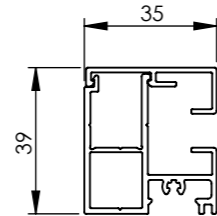

(1:2)

GUIDE WITH FILLING

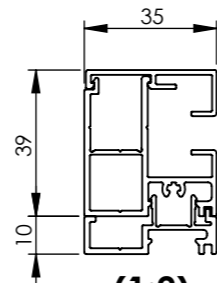

(1:2)

Not indicated size- and shape tolerances: EN

Not indicated wall thickness:

Design date: 7-2-2023

Printed on: 22-8-2023

EUROPEAN PROJECTION

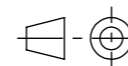

PROPERTY OF
HAROL[®]
Industriepark 3 - 3290 DIEST
TEL. 013/38 01 11 - Fax. 013/31 48 03

Designed by: Harol

Sheet: 4 of 7

Unit of measure: mm

Finish: BRUT

Ix=

Iy=

SCALE
1:8

Coolscreen 8 R

90 x 95

Surface area: -

Coating surface:

Material: ALU

S.G.:

Volume: -

Weight: -

STATUS

WIP

PLAN-NUMBER

D23-00002 - #_00

ARTICLE-NUMBER

SIDE VIEW section



SIDE VIEW right



FRONT VIEW

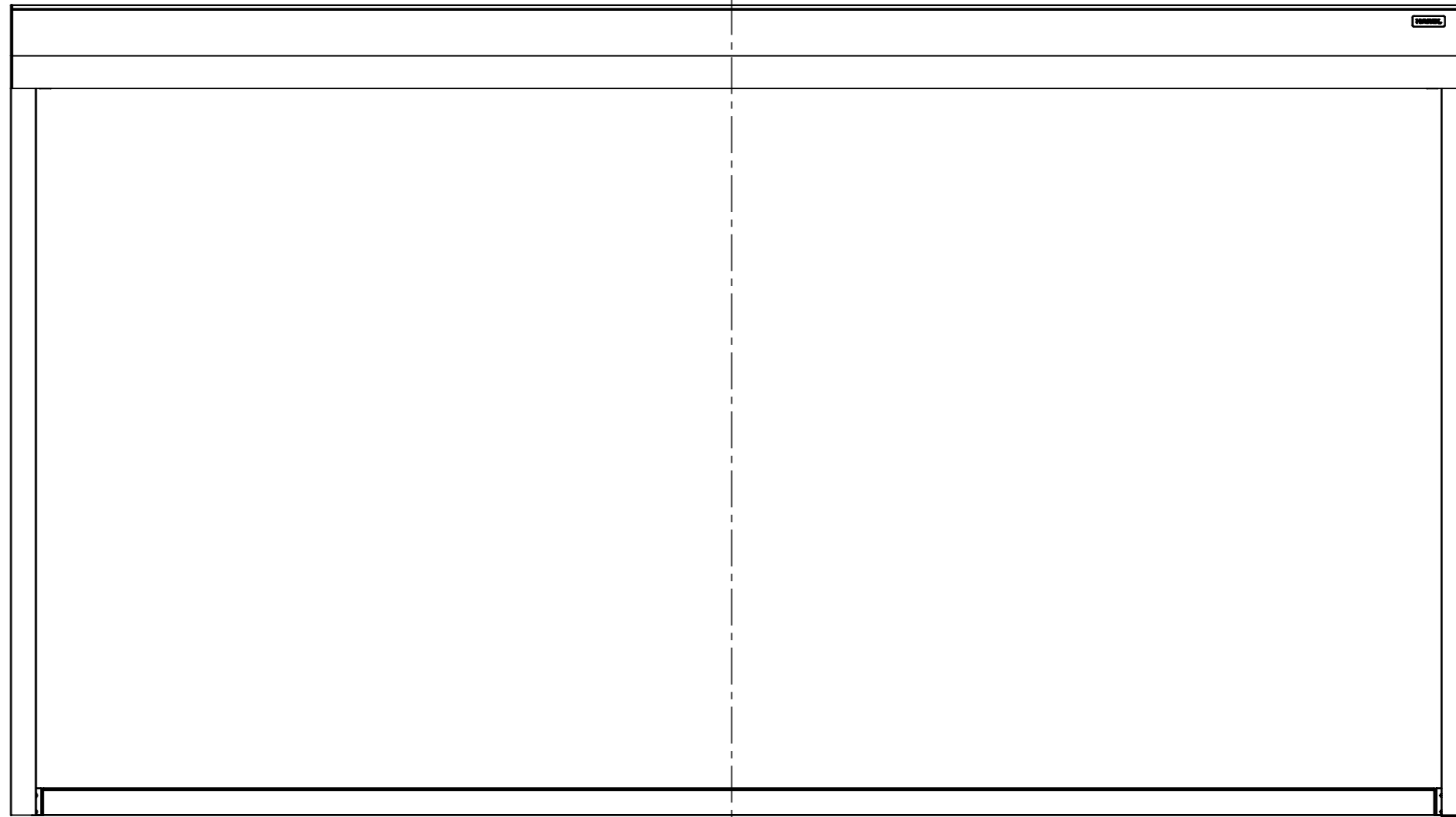

SIDE VIEW left

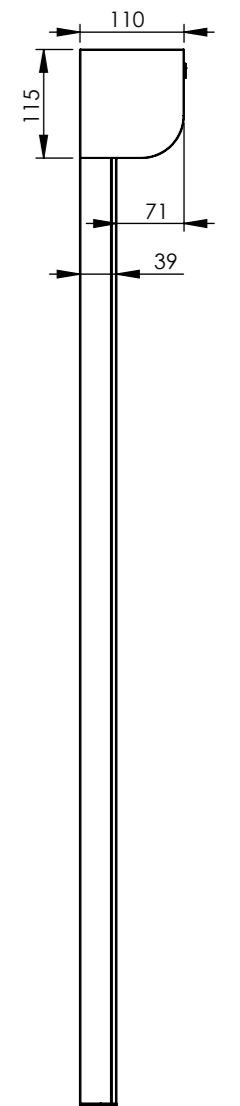

A-A (1 : 8)

TOP VIEW

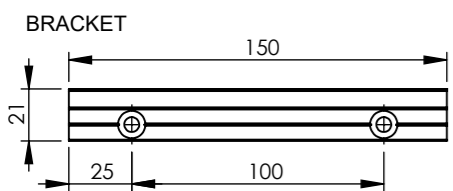
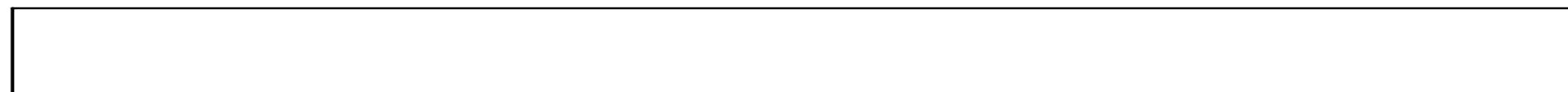

(1:3)

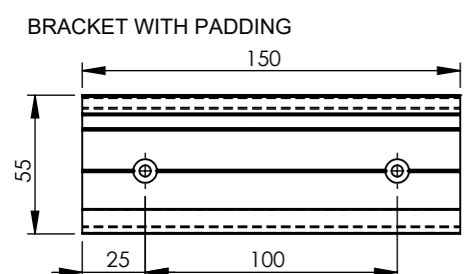

(1:3)

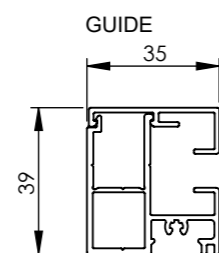

(1:2)

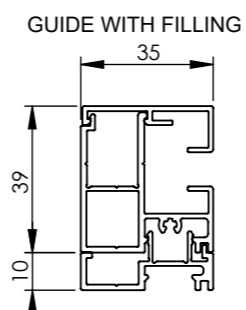

(1:2)

Not indicated size- and shape tolerances: EN

Not indicated wall thickness:

Design date: 7-2-2023

Printed on: 22-8-2023

EUROPEAN PROJECTION

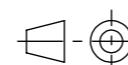

PROPERTY OF
HAROL[®]
Industriepark 3 - 3290 DIEST
TEL. 013/38 01 11 - Fax. 013/31 48 03

Designed by:

Sheet: 5 of 7

Unit of measure: mm

Finish: BRUT

Ix=

Iy=

SCALE
1:8

Coolscreen 8 R
110 x 115

Surface area: -

Coating surface:

Material:

S.G.: g/cm³

Volume: -

Weight: -

STATUS

WIP

PLAN-NUMBER

D23-00002 - #_00

ARTICLE-NUMBER

SIDE VIEW section

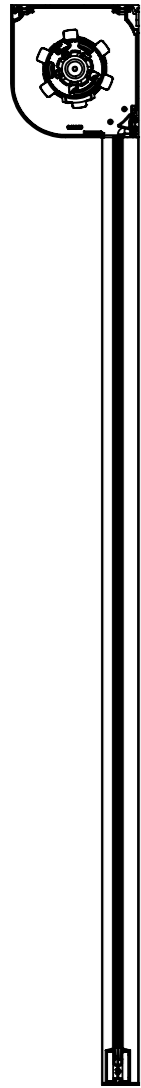

SIDE VIEW right

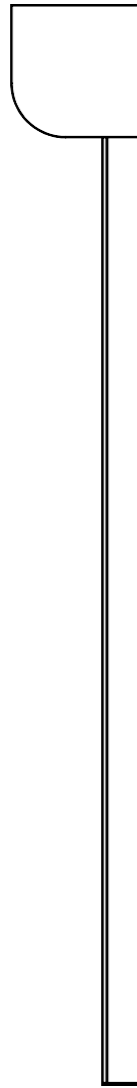

FRONT VIEW

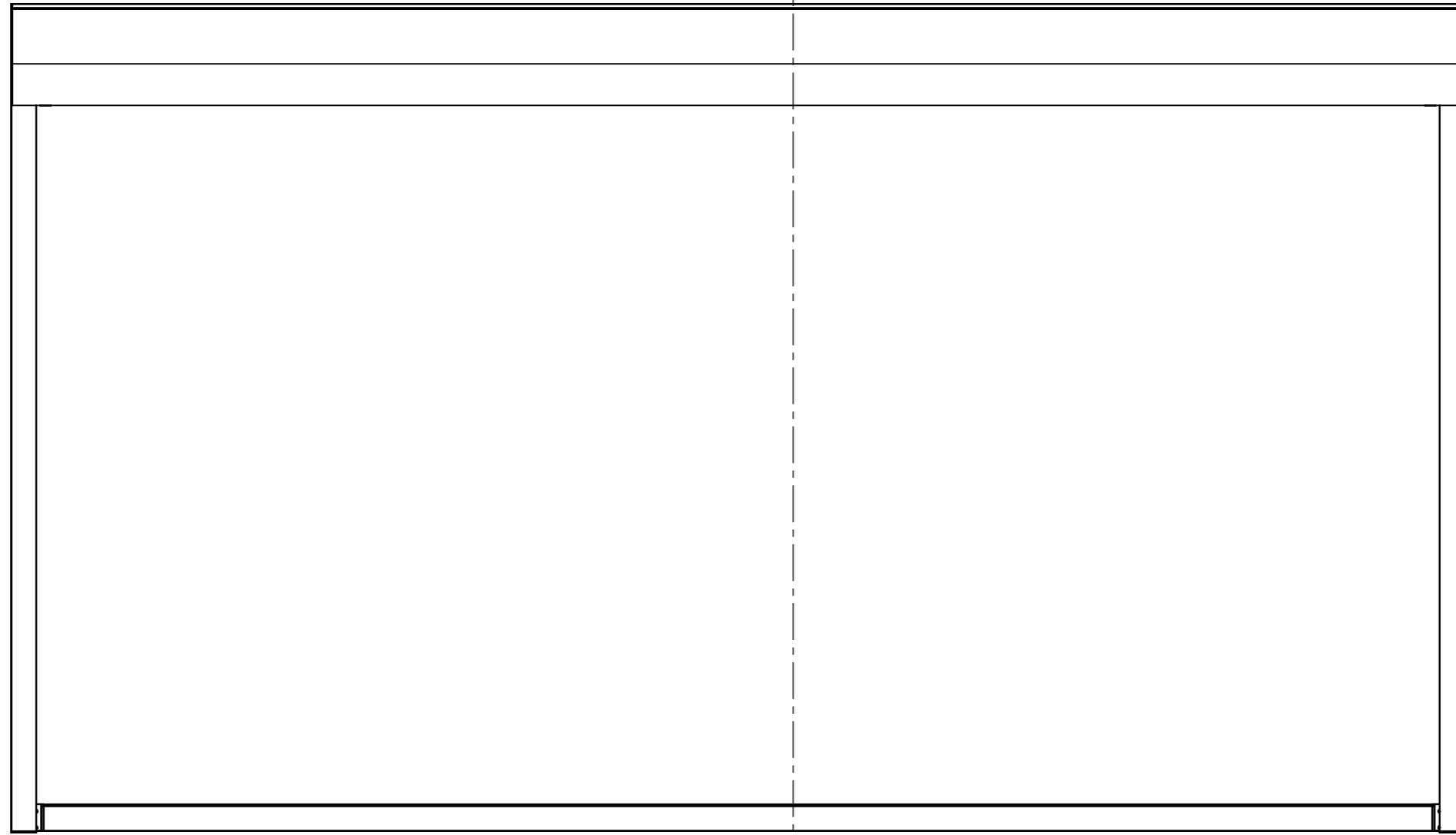

SIDE VIEW left

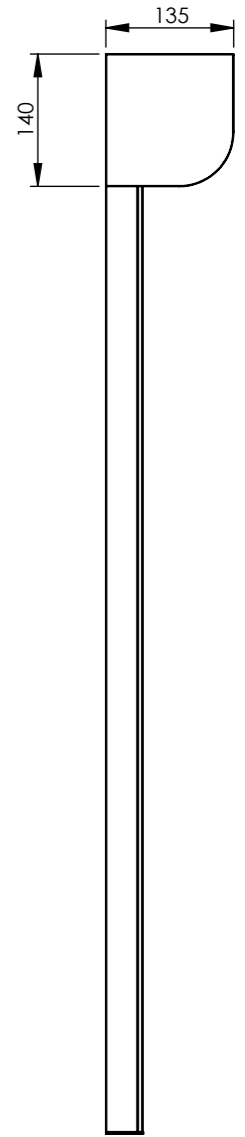

K-K

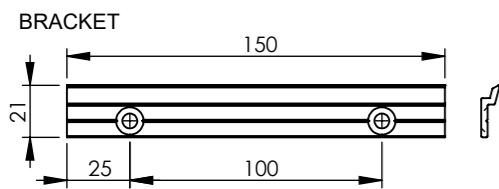

(1:3)

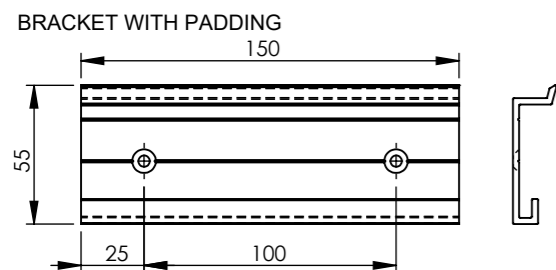

(1:3)

TOP VIEW

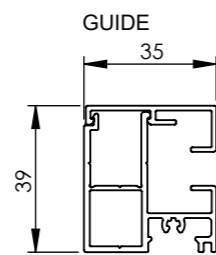

(1:2)

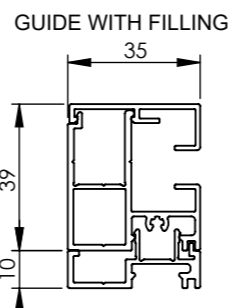

(1:2)

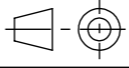
Not indicated size- and shape tolerances: EN		Not indicated wall thickness:		
Design date: 7-2-2023		Coolscreen 8 R 135 x 140		
Printed on: 22-8-2023				
EUROPEAN PROJECTION		Sheet: 6 of 7		
		Unit of measure: mm		
		Finish: BRUT		Surface area: -
PROPERTY OF		Coating surface:		Volume: -
HAROL [®]		S.G.:		Weight: -
Industriepark 3 - 3290 DIEST		STATUS		PLAN-NUMBER
TEL. 013/38 01 11 - Fax. 013/31 48 03		WIP		ARTICLE-NUMBER
		SCALE		
		1:8		
		D23-00002 - #_00		

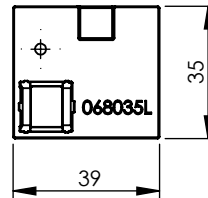
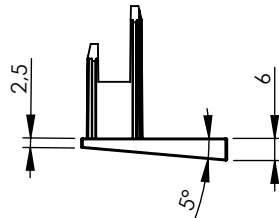
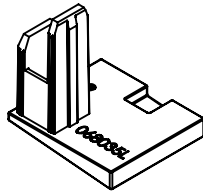
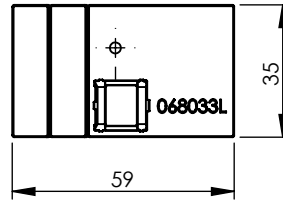
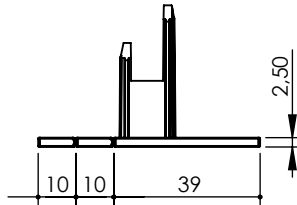
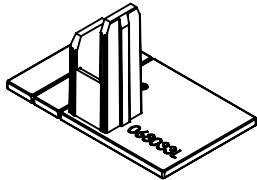
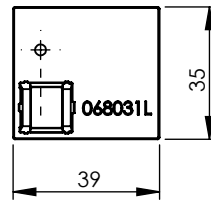
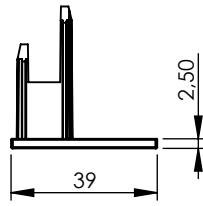
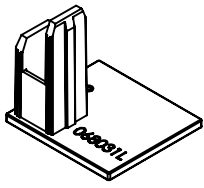

Not indicated size- and shape tolerances: EN

Not indicated wall thickness:

Design Date: 7-2-2023

Printed on: 22-8-2023

EUROPEAN PROJECTION

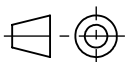

Designed by: mm

sheet: 7 of 7

unit of measure: mm

finish: NEUTRAAL

lx=

ly=

scale
1:1

Surface area:

Coating surface:

STATUS

WIP

PLAN-NUMBER

D23-00002 - #_00

Material:

S.G.:

Volume:

Weight:

ARTICLE-NUMBER

PROPERTY OF
HAROL®

Industriepark 3 - 3290 DIEST
TEL. 013/38 01 11 - Fax. 013/31 48 03

HAROL Coolscreen Eindstoppen